

G22-M2H

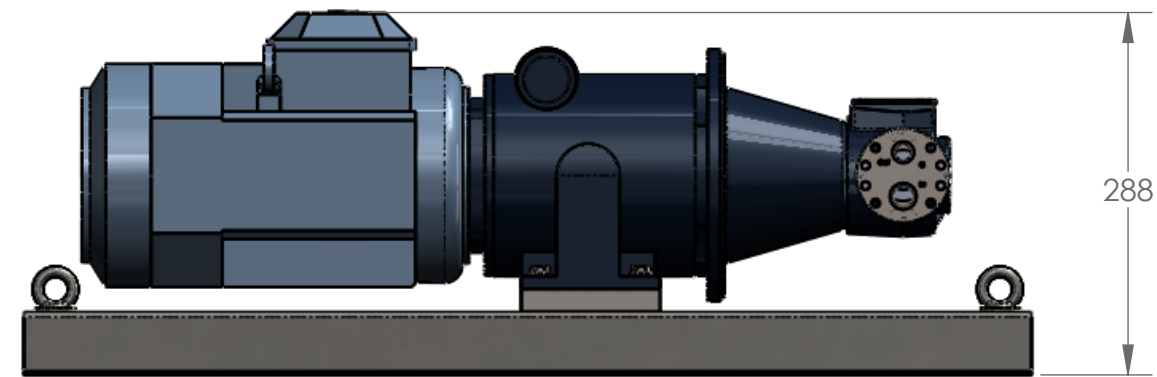
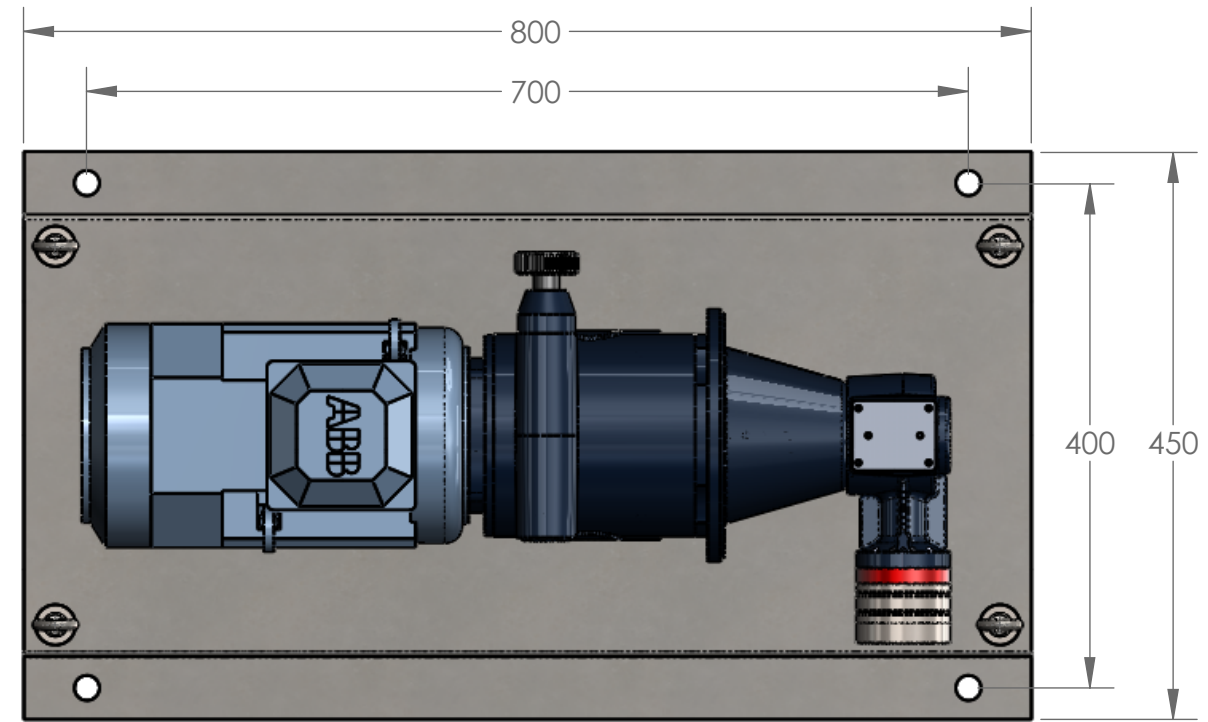

Unit Weight = 72 Kg