

G22-M4L

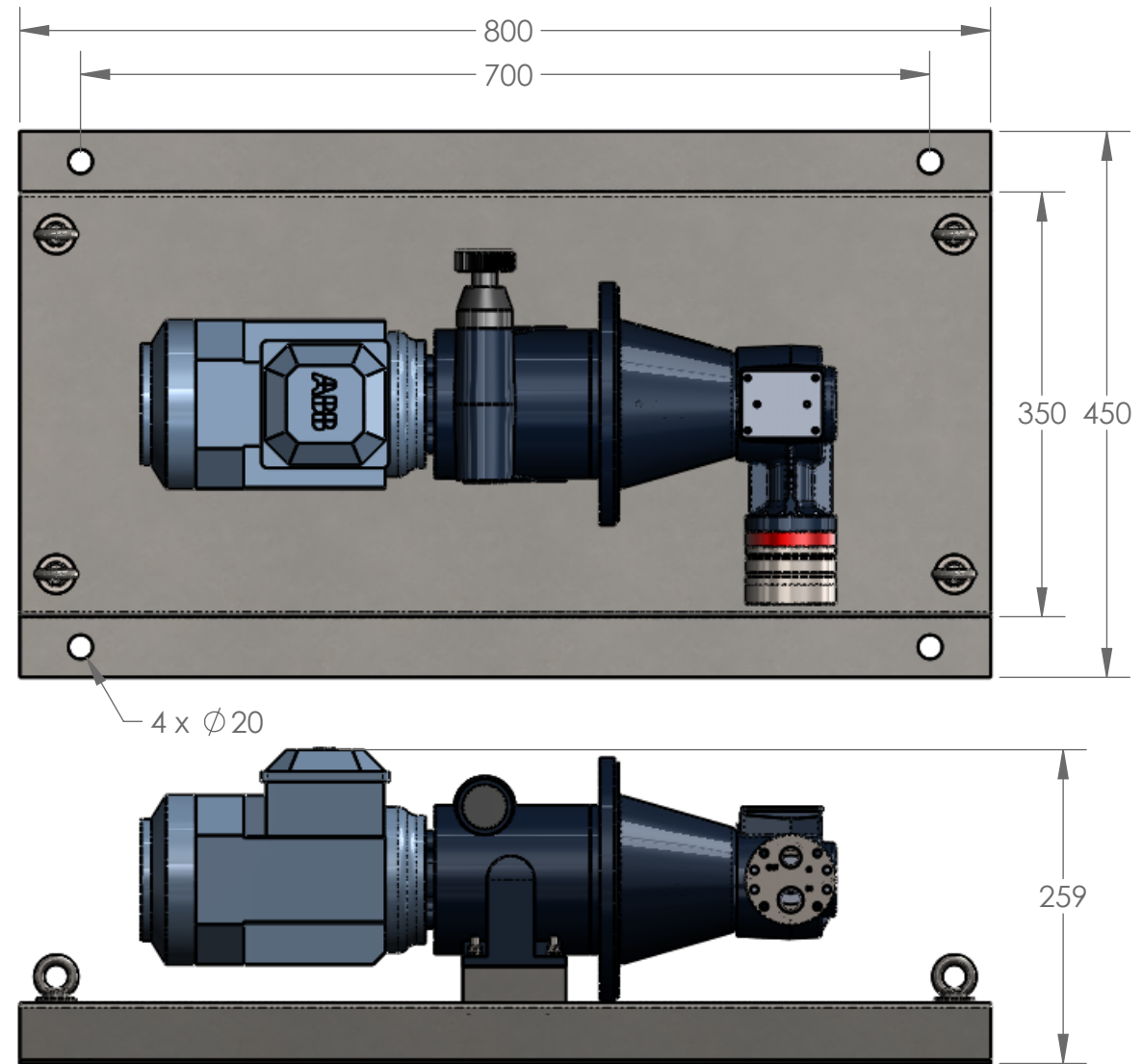

Unit Weight = 38 Kg