

G22-M6H

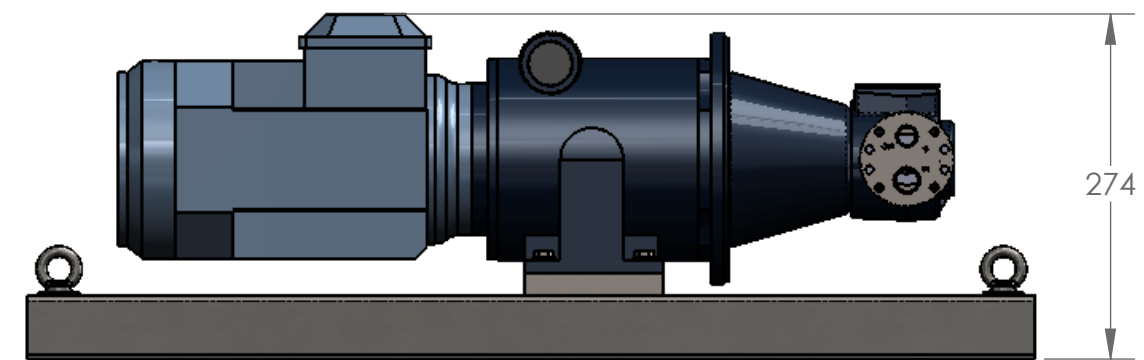
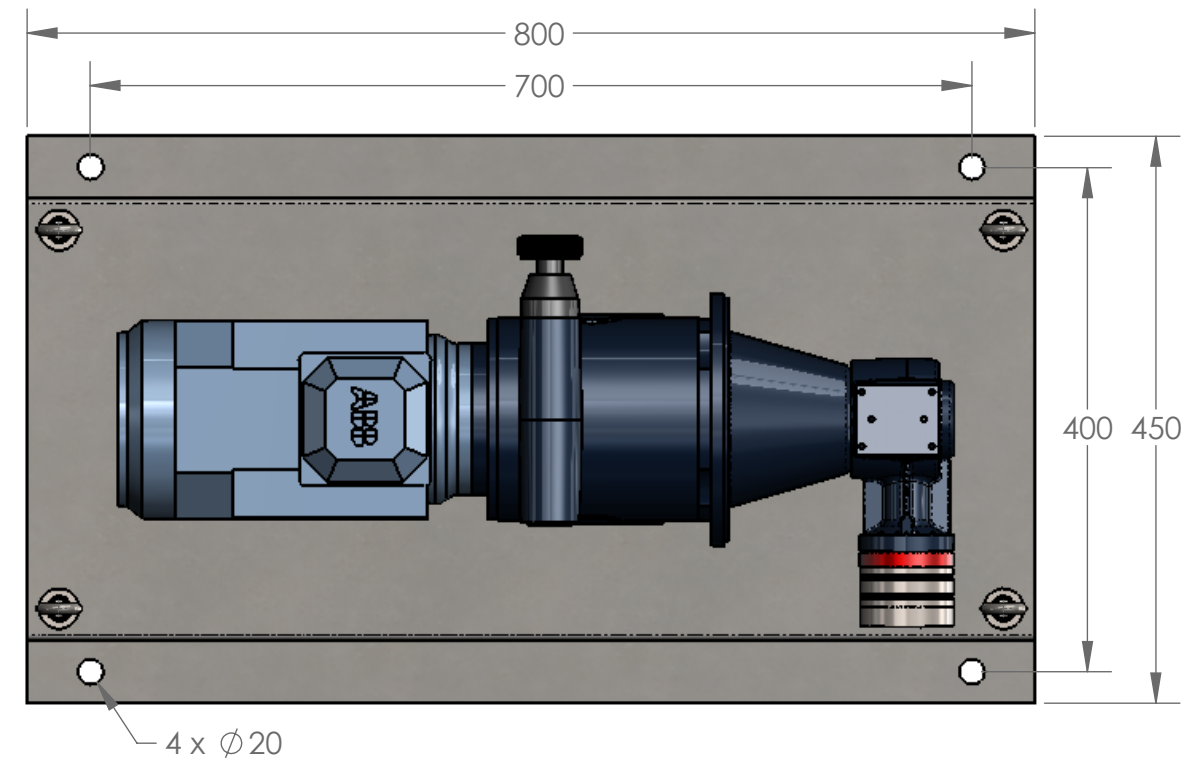

Unit Weight = 68 Kg