

G22-M6L

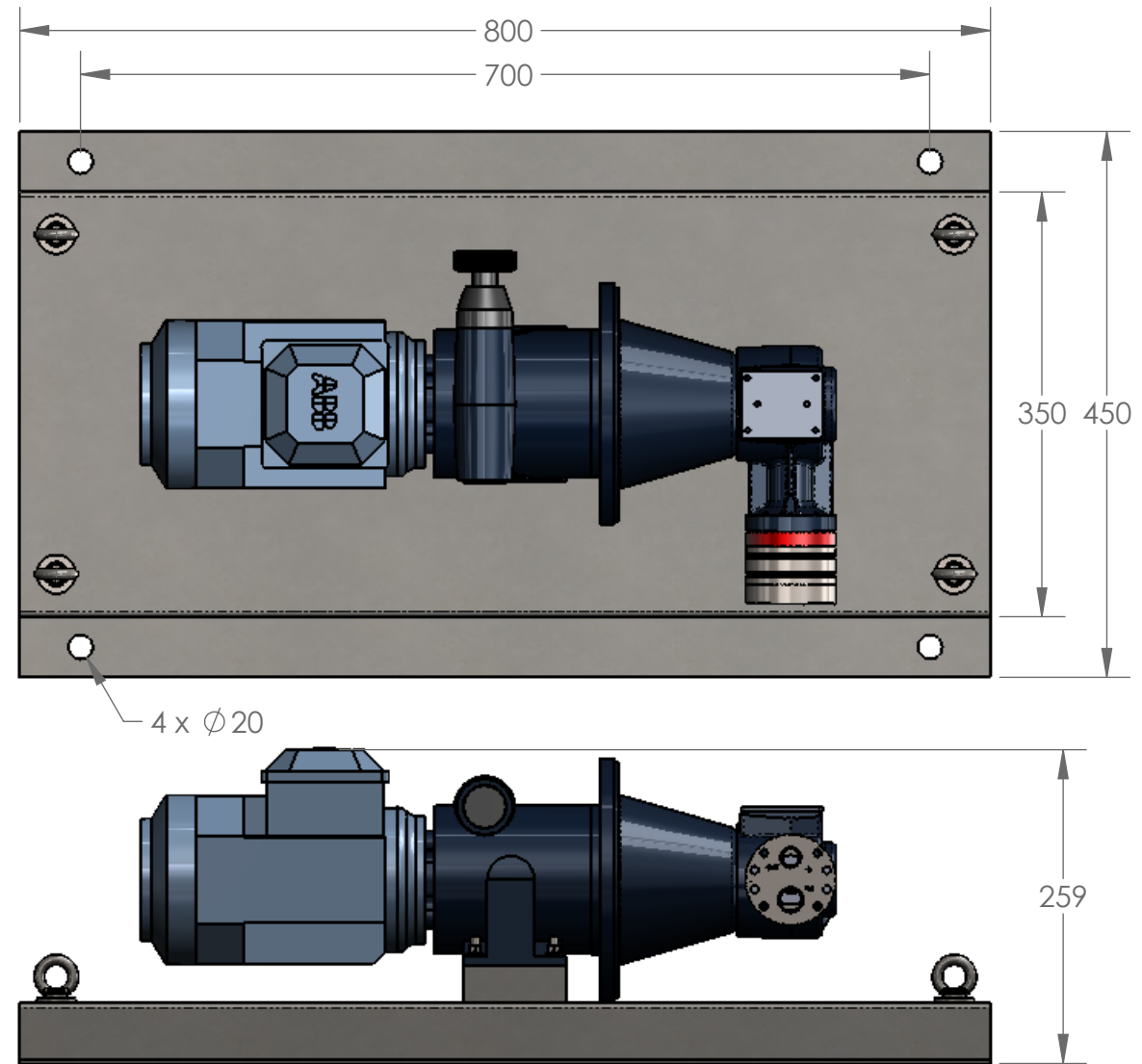

Unit Weight = 38 Kg